



# Russell Hobbs



instructions

**£10,000 prize draw**  
**EXTRA year guarantee**  
**FREE rewards gallery**

[www.russellhobbs.co.uk/productregister/](http://www.russellhobbs.co.uk/productregister/)  
Register online now!  
See back for details

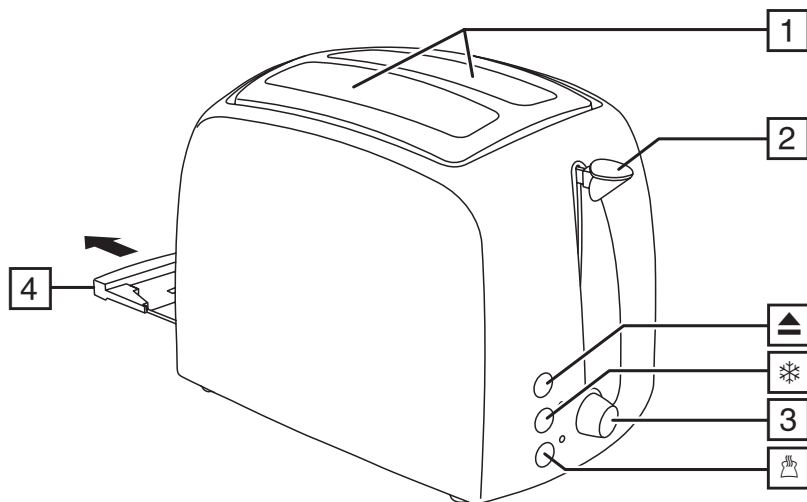

Read the instructions, keep them safe, pass them on if you pass the appliance on. Remove all packaging before use.



## **IMPORTANT SAFEGUARDS**

Follow basic safety precautions, including:

This appliance can be used by children aged from 8 years and above and persons with reduced physical, sensory or mental capabilities or lack of experience and knowledge if they have been supervised/instructed and understand the hazards involved.

Children shall not play with the appliance.

Cleaning and user maintenance shall not be done by children unless they are older than 8 and supervised.

Keep the appliance and cable out of reach of children under 8.

Don't connect the appliance via a timer or remote control system.

Bread may burn. Don't use the appliance near or below combustible materials (e.g. curtains).

 The surfaces of the appliance will get hot.

Remove and empty the crumb tray. Wipe with a damp cloth, dry, then replace in the toaster.

If the cable is damaged, return the appliance, to avoid hazard.

 Do not use this appliance near bathtubs, showers, basins or other vessels containing water.

- When using a single toasting slot, check that the other slot is empty.
- Don't toast or reheat "battered", torn, or misshapen bread.
- If bread gets jammed, unplug the toaster, let it cool, and carefully remove the bread.
- Don't use the appliance for any purpose other than those described in these instructions.
- Route the cable so it doesn't overhang, and can't be tripped over or caught.
- Don't cover the appliance or put anything on top of it.
- Don't operate the appliance if it's damaged or malfunctions.

## **HOUSEHOLD USE ONLY**

### **PARTS**

- |                   |                     |
|-------------------|---------------------|
| 1. toasting slots | 3. browning control |
| 2. lever          | 4. crumb tray       |



### **BEFORE USING FOR THE FIRST TIME**

1. Set the browning level to maximum (6).
2. Operate the appliance empty, to cure the new elements.
3. This may smell a bit, but it's nothing to worry about. Ensure the room is well ventilated.



## TOASTING BREAD

1. Sit the toaster upright on a firm, level, heat-resistant surface.
2. Put the plug into the power socket.
3. Turn the browning control to the required setting (1 = light, 6 = dark).
4. Put bread into the toasting slots (maximum thickness 26mm).
5. Press the lever down fully. It won't lock down unless the toaster is connected to the electricity supply.
6. The elements will heat up.
7. When it's done, the toast will pop up.
8. To stop toasting, press .

## FROZEN BREAD

1. Leave the browning level at your favoured setting, insert the frozen bread, lower the lever, then press .
2. The  light will glow, and the toasting time will be altered automatically to give the same degree of browning you get with unfrozen bread.

## REHEATING TOAST

1. Leave the browning control at your favoured setting, insert the bread, lower the lever, then press .
2. The  light will glow, and the toast will be given a short burst of heat.
3. Don't reheat "battered", torn, or misshapen bread.

## HINTS AND TIPS

- Old (yesterday's) bread has less moisture, so makes crisper toast.
- Old bread, thin slices, and sweet bread products (tea cakes, fruit loaf, etc.) brown faster – use a lower setting.

## CARE AND MAINTENANCE

- Unplug the toaster and let it cool down.
- Wipe outer surfaces with a damp cloth.







## ENVIRONMENTAL PROTECTION

To avoid environmental and health problems due to hazardous substances in electrical and electronic goods, appliances marked with this symbol mustn't be disposed of with unsorted municipal waste, but recovered, reused, or recycled.

## SERVICE

If you ring Customer Service, please have the **Model No.** to hand, as we won't be able to help you without it. It's on the rating plate (usually underneath the product).

The product isn't user-serviceable. If it's not working, read the instructions, check the plug fuse and main fuse/circuit breaker. If it's still not working, consult your retailer.

If that doesn't solve the problem – ring Customer Service – they may be able to offer technical advice.

If they advise you to return the product to us, pack it carefully, include a note with your name, address, day phone number, and what's wrong. If under guarantee, say where and when purchased, and include proof of purchase (till receipt). Send it to:

Customer Service

Spectrum Brands (UK) Ltd

Fir Street, Failsworth, Manchester M35 0HS

email: [support@russellhobbs.com](mailto:support@russellhobbs.com)

telephone: 0845 658 9700 (local rate number)

## GUARANTEE

Defects affecting product functionality appearing within two years of first retail purchase will be corrected by replacement or repair provided the product is used and maintained in accordance with the instructions. Your statutory rights are not affected. Documentation, packaging, and product specifications may change without notice.

## ONLINE/SPARES

[www.russellhobbs.co.uk](http://www.russellhobbs.co.uk) for more products and/or spares

## REGISTER ONLINE FOR –

 £10,000 prize draw,

 EXTRA year guarantee,

 FREE rewards gallery

Visit [www.russellhobbs.co.uk/productregister/](http://www.russellhobbs.co.uk/productregister/)

You must register within 28 days of purchase.