



Russell Hobbs



instructions

£10,000 prize draw
EXTRA year guarantee
FREE rewards gallery

www.productregister.co.uk/rhobbs
Register online now!
See back for details

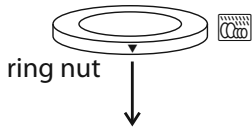

cutters

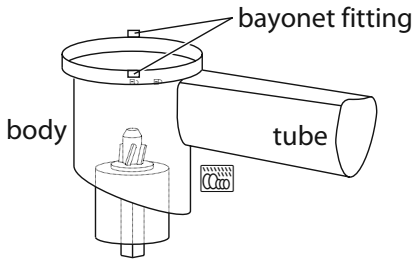
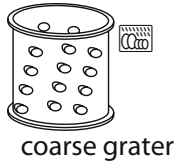
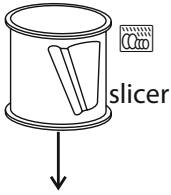

cutter (rear)

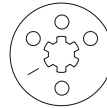

 = dishwasher safe

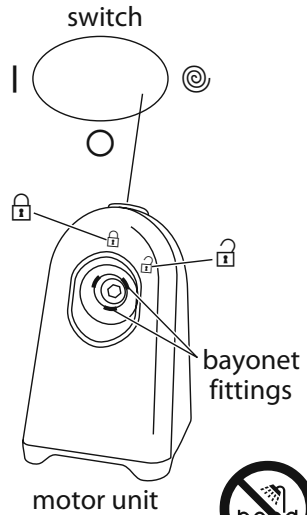
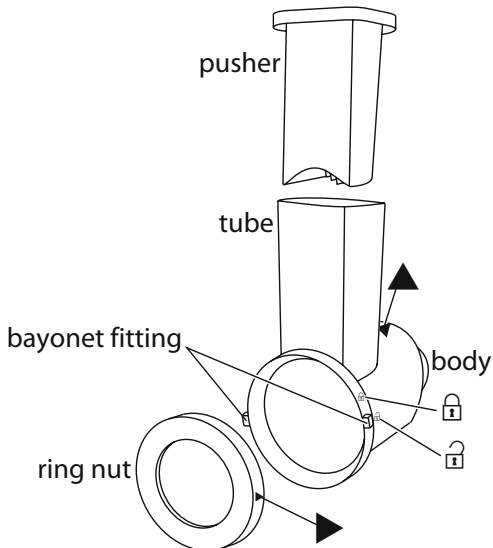

Read the instructions, keep them safe, pass them on if you pass the appliance on.
Remove all packaging before use.



IMPORTANT SAFEGUARDS

Follow basic safety precautions, including:

- 1 This appliance can be used by children aged from 8 years and above and persons with reduced physical, sensory or mental capabilities or lack of experience and knowledge if they have been supervised/instructed and understand the hazards involved. Children shall not play with the appliance. Cleaning and user maintenance shall not be done by children unless they are older than 8 and supervised. Keep the appliance and cable out of reach of children under 8 years.
- 2 If the cable is damaged, return the appliance, to avoid hazard.
-  Don't put the motor unit in liquid, don't use the appliance in a bathroom, near water, or outdoors.
- 3 Don't touch the insides of the cutters.
- 4 Don't use fingers or cutlery to push food down the tube – only the pusher.
- 5 Don't use the appliance for any purpose other than those described in these instructions.
- 6 Don't run the motor continuously for more than 10 minutes, it may overheat. After 10 minutes switch off for at least 10 minutes, to recover.
- 7 Unplug the appliance before fitting or removing attachments.
- 8 Don't operate the appliance if it's damaged or malfunctions.

household use only

ASSEMBLY

- 1 Switch the appliance off (○) and unplug it.
- 2 Hold the tube, and turn the body till the hole is uppermost.
- 3 Lower one of the cutters into the hole, till it engages with the drive.
- 4 Align the ring nut with the bayonet fittings on the hole.
- 5 Turn the ring nut 10mm anti-clockwise, to lock the cutter into the body.
- 6 Turn the body till the tube is vertical.
- 7 Now turn it 45° clockwise, to engage the bayonet fittings inside the motor unit.
- 8 Turn it 45° anti-clockwise, to lock it in place.



WARNING

Don't put your fingers inside the cutters.

IN USE

- 9 Cut the food to a shape that will go down the tube (45x35mm).
- 10 Put the plug into the power socket.

11 Move the switch:

- | on
- off
- ⊗ pulse

In this position, the switch is spring-loaded. When you let go, it'll return to ○.

12 Remove the pusher, and drop the ingredients down the tube.

13 Replace the pusher, and use it to push the ingredients gently down the tube.

DISASSEMBLY

14 Switch the appliance off (○) and unplug it.

15 Turn the body 45° clockwise, to disengage the bayonet fittings, and pull it off the motor unit.

16 Turn the ring nut 10mm clockwise, to unlock it, and lift it off the body.

17 Tip the body up, so that the cutter drops out.

JAMMING

18 Switch the appliance off (○) and unplug it.

✱ Dismantle the appliance, clean it, assemble it, and start again.

CARE AND MAINTENANCE

19 Switch the appliance off (○) and unplug it.

20 Wipe the outside of the motor unit with a clean damp cloth.

21 Wash the removable parts in warm soapy water, rinse well, drain, and air dry.

 You may wash these parts in a dishwasher.

22 Carotenoids, which are found in many other vegetables as well as carrots, can cause severe staining. This staining may be impossible to remove. Don't worry about it, it won't affect the operation of the appliance.

23 Rubbing the stains with cooking oil immediately before washing may help.

24 Cleaning the affected parts in a dishwasher may reduce the staining.

25 If you use a dishwasher, the harsh environment inside the dishwasher will affect the surface finishes.

26 The damage should be cosmetic only, and should not affect the operation of the appliance.

STORAGE

27 You may store two of the cutters in the spaces in the rear of the appliance.

NOISE

28 If you find the appliance is noisy, the cutter may be rubbing against the ring nut.

29 Applying a little cooking oil to the inside of the ring nut before use should fix this.

ENVIRONMENTAL PROTECTION

To avoid environmental and health problems due to hazardous substances in electrical and electronic goods, appliances marked with this symbol mustn't be disposed of with unsorted municipal waste, but recovered, reused, or recycled.

SERVICE

If you ring Customer Service, please have the **Model No.** to hand, as we won't be able to help you without it. It's on the rating plate (usually underneath the product).

The product isn't user-serviceable. If it's not working, read the instructions, check the plug fuse and main fuse/circuit breaker. If it's still not working, consult your retailer.

If that doesn't solve the problem – ring Customer Service – they may be able to offer technical advice.

If they advise you to return the product to us, pack it carefully, include a note with your name, address, day phone number, and what's wrong. If under guarantee, say where and when purchased, and include proof of purchase (till receipt). Send it to:

Customer Service

Spectrum Brands (UK) Ltd

Fir Street, Failsworth, Manchester M35 0HS

email: service@russellhobbs.com

telephone: 0845 658 9700 (local rate number)

➔ GUARANTEE

Defects affecting product functionality appearing within two years of first retail purchase will be corrected by replacement or repair provided the product is used and maintained in accordance with the instructions. Your statutory rights are not affected. Documentation, packaging, and product specifications may change without notice.

ONLINE

www.russellhobbs.co.uk for more products

REGISTER ONLINE FOR –

£10,000 prize draw, EXTRA year guarantee, FREE rewards gallery

Visit www.productregister.co.uk/rhobbs

You must register within 28 days of purchase.

